

Founded in 1875, Shimadzu Corporation, a leader in the development of advanced technologies, has a distinguished history of innovation built on the foundation of contributing to society through science and technology. We maintain a global network of sales, service, technical support and applications centers on six continents, and have established long-term relationships with a host of highly trained distributors located in over 100 countries. For information about Shimadzu, and to contact your local office, please visit our Web site at www.shimadzu.com



SHIMADZU CORPORATION, International Marketing Division

3, Kanda-Nishikicho 1-chome, Chiyoda-ku, Tokyo 101-8448, Japan

Phone: 81(3)3219-5641 Fax: 81(3)3219-5710

URL <http://www.shimadzu.com>



Shimadzu Corporation Medical Systems Group has been certified by TÜV Rheinland as a manufacturer of medical equipment and systems in compliance with ISO9001:2000 Quality Management Systems and ISO13485:2003 Medical Equipment Quality Management Systems.

Remarks:

※Every value in this catalogue is a standard value, and it may vary a little from the actual at each site.

※The appearances and specifications are subject to change for reasons of improvement without notice.

※Certain configurations may not be available pending regulatory clearance. Contact your Shimadzu representative for information on specific configurations.

※Before operating this system, you should first thoroughly review the Instruction Manual.

 **SHIMADZU**
Solutions for Science
since 1875

Remote Controlled R/F System

FLEXA VISION
series



Remote Controlled R/F system
FLEXAVISION
series

Numerous system configurations easily accommodate a wide variety of examinations

The specifications of the main system components, the FLEXAVISION R/F table, the high-voltage generator, and the X-ray tube, can be selected from a variety of different options. This flexibility in configuration makes the system suitable for a wide variety of examinations, ranging from gastrointestinal and other types of screening to urological and orthopedic examinations.

- Flexibility
- Patient Care
- Image Quality
- Workflow
- Reliability



Elevating table



Standard table

- FLEXAVISION HB package**
Hybrid (SFD & Digital) system
- FLEXAVISION SF package**
Cassette SFD system
- FLEXAVISION FD package**
Full digital system

Flexibility

Thanks to a wide variety of R/F table types, high-voltage generators, X-ray tubes, I.I. sizes and digital processing units, FLEXAVISION allows you to create an optimal system that accommodates both your patient throughput requirement and all your examination types. Even though the system is compact, its rapid movement and wide patient coverage allow for precise

positioning in the area of interest. This ensures easy selection of the optimal system for both standard gastrointestinal, thoracic, and abdominal examinations, as well as specialized nonvascular IVR, urological and orthopedic examinations.



X-ray high-voltage generator
50 kW
80 kW

I.I.
9 inch type
12/9 inch type
12/9/7.5/6 inch type*
(* HB, FD types)

X-ray tube unit
400 kHU, 300 kHU
200 kHU



Elevating table



Standard table

FLEXAVISION HB package : Hybrid (SFD & Digital) system
FLEXAVISION SF package : Cassette (CR) SFD system
FLEXAVISION FD package : Full digital system

Console
Standard type
Desktop type



14" CRT (SF type)



17" LCD (HB, FD types)



Desktop type



Extensive Examination Coverage
Provides full-body coverage for gastrointestinal, nonvascular IVR and urological examinations.



Oblique Projection Unit **OPTION**
Ensures suitability for general radiography, orthopedic and enema examinations.



Imaging Chain Extension **OPTION**
Imaging chain extension is 1.5 m (standard) or 1.8/2.0 m (option). In combination with cassette radiography, this option provides thoracic radiography and swallowing function tests on wheelchair patients.

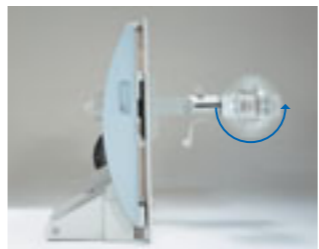

X-ray Tube 180° Swing Unit **OPTION**
180-degree rotation of the X-ray tube/collimator easily and effectively accommodates chest examinations using a bucky stand.



Urological Option **OPTION**
Perform urological examinations in combination with cassette radiography.



Auxiliary Tabletop **OPTION**
Provides superb patient support during ERCP, lower extremity venography, or orthopedic radiography of the lower extremities.

- Either oblique projection unit or imaging chain extension unit (1.8 m/2.0 m) can be selected.
- Fluoroscopy can not be performed with 1.8m/2.0m FFD.

A comprehensive range of options meet a wide variety of needs.

- * Oblique projection unit (orthopedic, gastrointestinal) * Lateral cassette holder (general radiography)
- * Compression band * Rolling step (screening) * Endoscope support (endoscopy) * X-ray tube swing-out unit (general radiography)
- * Foot switch (interventional radiology, orthopedics, etc.) * Local console (interventional radiology, orthopedics, etc.) * DICOM software (FD, HB types)

Patient Care

Patient care is the keyword when evaluating the design of the FLEXAVISION system. Enjoy an extensive range of functions designed to assist staff and patients alike. This includes table elevation to ease the strain of patient changeover, bedside switches for unit positioning while providing bedside care, digital radiography (HB, FD types) and spot filming (HB, SF types) to reduce patient restraint times during examinations. X-ray dose during examinations are a major concern for both operators and patients. As a result, FLEXAVISION standard features include low-dose pulsed fluoroscopy (HB, FD types) and a beam hardening filter to reduce total X-ray dose.



Bedside Switches

Tabletop and imaging chain operation switches are provided on the tabletop to allow examinations and positioning while caring for the patient.



Table Elevation

This function reduces strain during patient changeover and allows the technologist to easily and safely transfer patients on and off the table. The elevating tabletop also allows the technologist to select their most comfortable examination height.



Full-Body Stroke

Generous 133 cm (17"×14" cassette) examination range accommodates all examination types and minimizes need for patient movement.



Cassette Spot Filming

One-touch-loading cassette ensures well-timed radiography. (HB, SF types)



Cassette Radiography

Spot filming function uses cassettes to extend the viewing field.

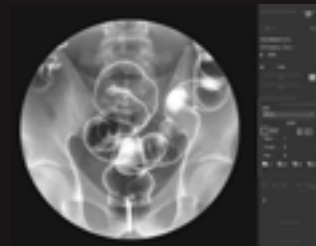

Pulsed fluoroscopy function

3.75 fps

7.5 fps

15 fps

Digital Image Display

Acquired images appear instantly on the monitor, helping to reduce patient restraint time. (HB, FD types)

Reduced X-ray Exposure

Standard equipment pulsed fluoroscopy (HB, FD types) and beam hardening filter reduce exposure to unnecessary X-rays.





Image Quality

FLEXAVISION provides outstanding image quality. The high-performance, 1-megapixel CCD camera (HB, FD types) allows 1024 x 1024 matrix and 12-bit (4096 gradation) imaging. This ensures image quality of high definition and high-density resolution. Shimadzu's digital processing is applied to suppress halation and provide clear images with superb contrast for realtime image review. Multi-cassette spot film device (HB, SF types) provides similar digital image capture, enabling efficient image review during urological and abdominal examinations that require a wide viewing field.

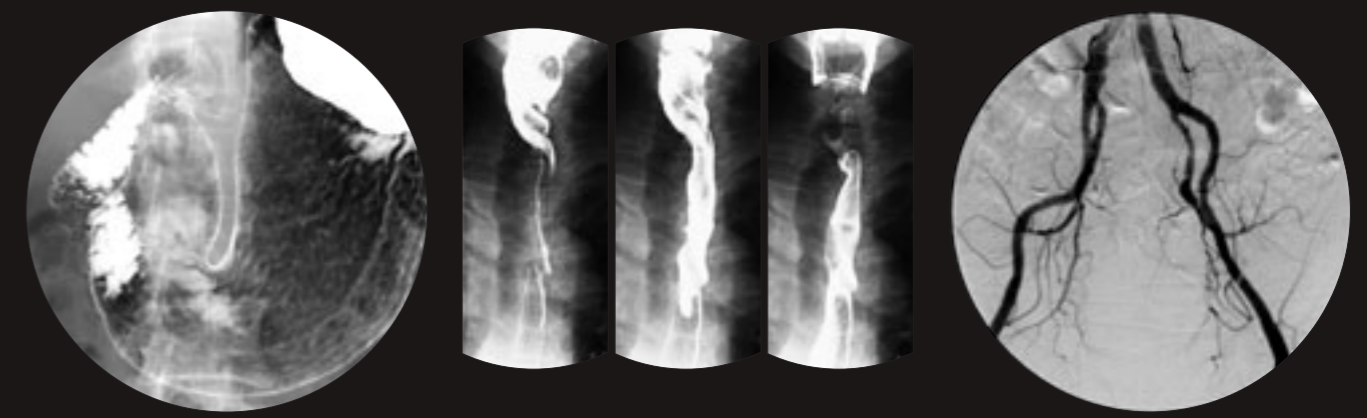

High-Definition Digital
1024 x 1024 matrix
12-bit (4096 gradations)

Digital Serial Radiography
Serial radiography at 3 fps is effective for esophageal examinations.
(7.5 fps serial : option)

DSA Capability OPTION
High-speed, high-definition real-time DSA is available at 7.5 fps on a 1024 x 1024 matrix.

Workflow

Controls for FLEXAVISION R/F table operation and the high-voltage generator are concentrated in a single operation console to ensure a smooth and accurate workflow for all types of examinations. Systems incorporating a digital image processor (HB, FD types) use the highly flexible Windows® operating system to provide realtime image viewing via simple mouse or keyboard operation. Optional DICOM-network compatibility simplifies printing and image transfer to a server, ensuring an overall high-quality workflow.



R/F table operations and high-voltage generator controls are concentrated in an easy-to-use layout.



Use the tabletop-type console to operate the R/F table and high-voltage generator from a standard work desk.

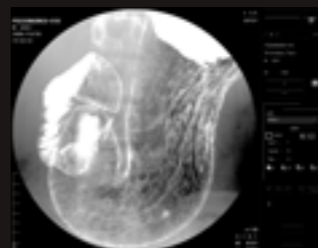

Simple Windows®-based mouse and keyboard operation simplifies system operation and image review (HB, FD types)

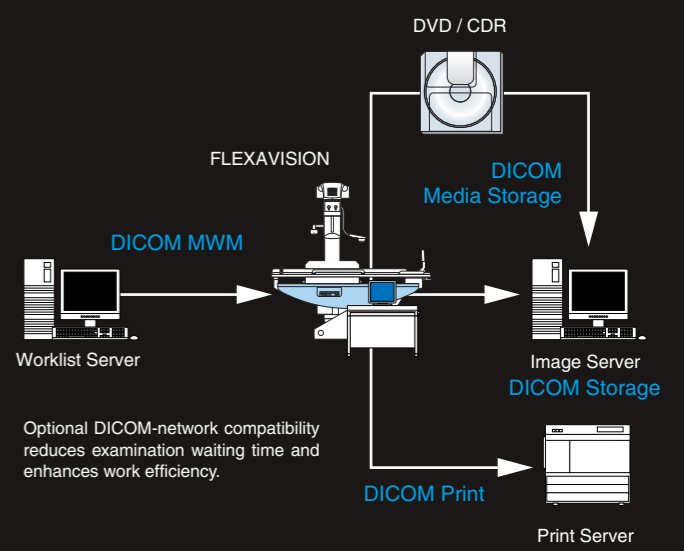

Optional DICOM-network compatibility reduces examination waiting time and enhances work efficiency.

FLEXAVISION can output images in JPEG or BMP file format.

Reliability

Since Shimadzu developed the world's first remote X-ray R/F system in 1961, the company has remained at the forefront of R/F and other X-ray system technologies. We have established an outstanding international reputation and based on this extensive expertise, FLEXAVISION has been designed to deliver the high level of performance demanded by today's clinical environment. As an example, to produce uniformly high image quality, everything from the R/F table to the digital systems, including the high-voltage generator, X-ray tube and image intensifiers, were developed and manufactured by Shimadzu to create a true integrated system. In addition, Shimadzu service centers around the world respond rapidly to customer requests in order to constantly maintain high levels of quality.

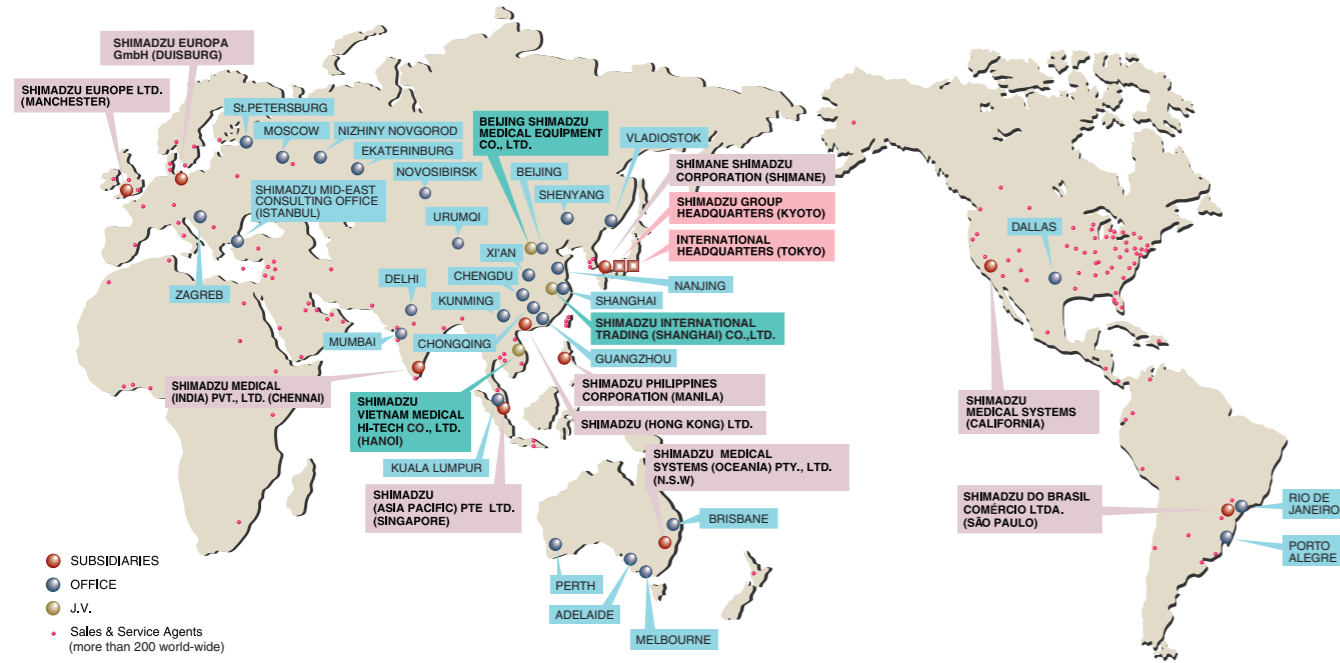

DIMENSIONS

Unit : mm

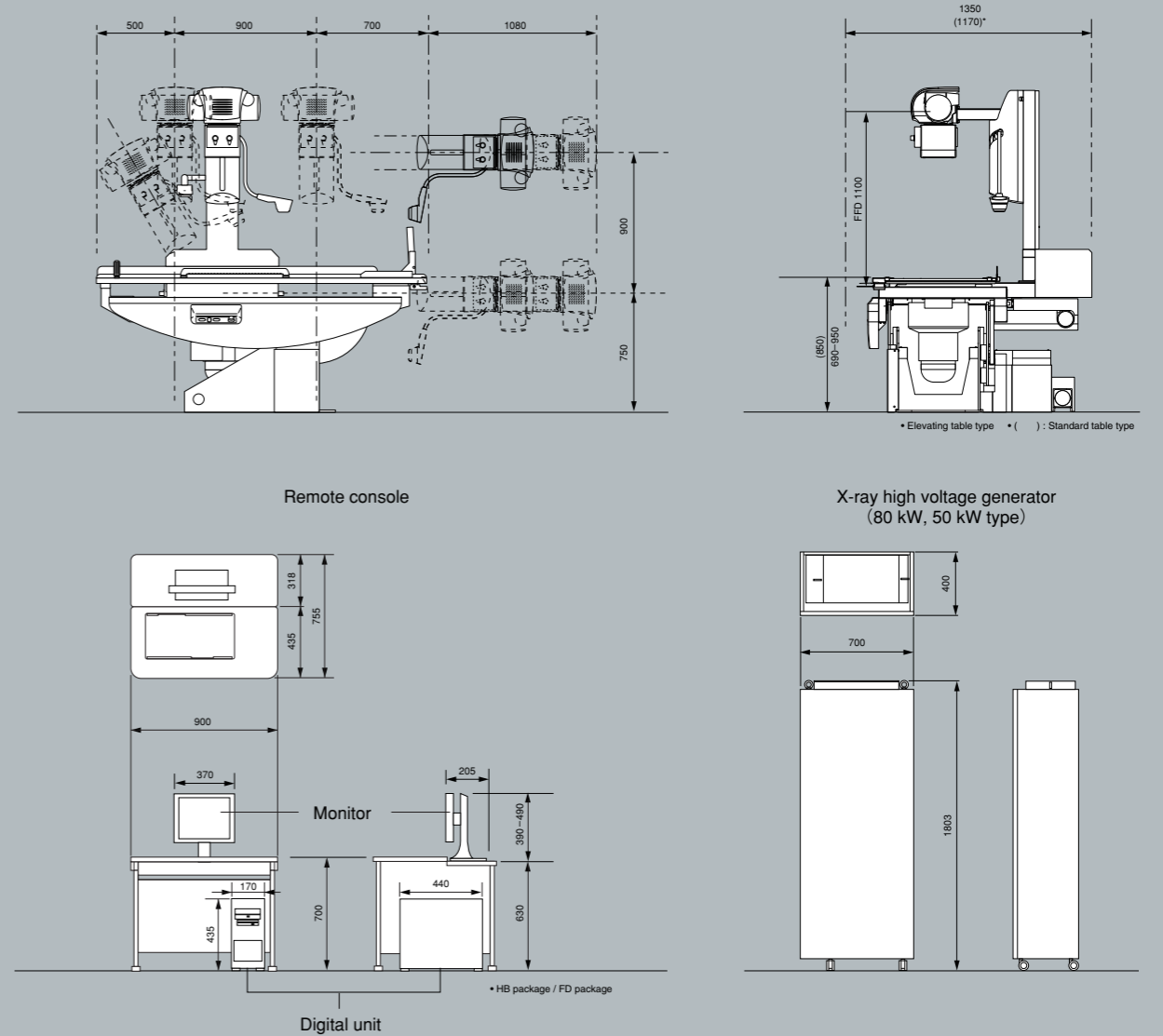

Specification

	SF package	HB package	FD package
Generator (selectable)	50 kW, 80 kW		
X-ray tube (selectable)	200 kHU, 300 kHU, or 400 kHU		
Image Intensifier (selectable)	9 inch, 12 inch (2 fields)	9 inch, 12 inch (2 fields), 12 inch (4 fields)	
Table tilt	+90 to -30 degrees		
Table elevation	69 cm to 95 cm (factory installed option)		
Patient coverage	133 cm (imaging unit travel 90 cm + 43 cm CR/Film) (option: table top extension for flexible positioning)		
FFD extension	1.5 m (standard.) or 1.8 m/2.0 m* (factory installed option) * Not available with oblique projection (1.8m/2.0m FFD extension or oblique)		
Oblique projection	+/- 30 degrees (factory installed option) Not available with 1.8 m/2.0 m FFD extension (FFD extension or oblique)		
TV camera	400,000 pixel CCD camera	1 million pixel CCD camera	
Monitor (selectable)	14" CRT, 14" LCD	17" LCD, 18" LCD	
SFD / Cassette tray	Multi-size Spot Film Device		Cassette Tray
Digital processor	N.A.	1024 matrix, 12 bit, 3 fps (7.5 fps, optional)	
Pulsed fluoroscopy	N.A.	Max 15 fps	
DICOM compatibility	N.A.	DICOM Print (standard.), DICOM Storage (option.), DICOM MWM (option.)	
Media storage	N.A.	CD-R/DVD-R/DVD-RAM	